

DIGITAL, PROGRAMMABLE, PLUG & PLAY,

IGBT DRIVER

1IPSE1S45-100

FOR MEDIUM AND HIGH POWER IGBTs

D A T A S H E E T

InPower Systems GmbH

Am Kornfeld 11
D-86932 Pürgen, Germany
Tel: +49-(0)8196-93000
Fax: +49-(0)8196-930020
Email: info@inpower-sys.com
VAT-Id: DE 221021830

Prepared by: M. Wendt
Approved by: P. Kviz
Date of publication: January 2011
Revision: 1.3
Status: production

1. MAIN FEATURES

- Single channel for dual- and multilevel topology
- Smart switching with variable gate resistors
- Tuned according to the application
- Reliable protection against
 - over-current in all short circuit conditions
 - over-voltage during turn-off
- Advanced control and protection functions
 - four level desaturation monitoring
 - two level di/dt monitoring
 - feedback clamping with active function
 - multiple soft shut down
 - supply voltage monitoring
 - digital input filter for switching signals
- DC/DC converter included
- Screw connection with high power IGBT modules (base plate 130x140mm or 190x140mm)



2. MECHANICAL DIMENSIONS

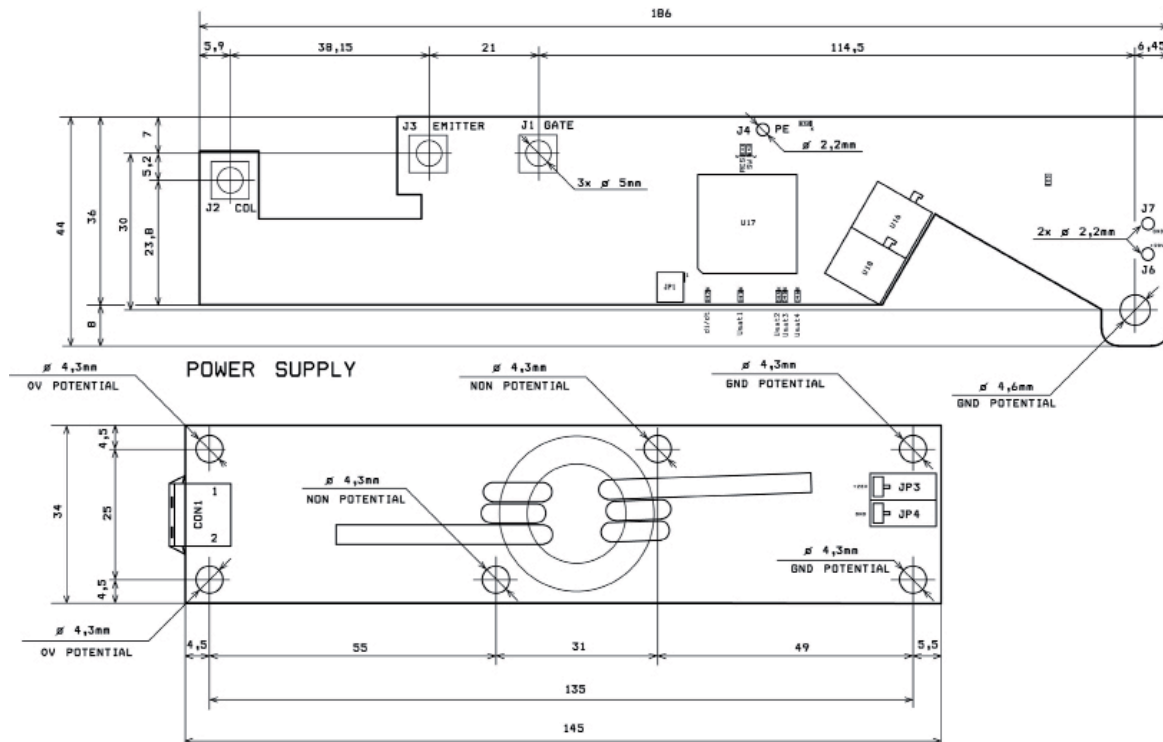

3. KEY DATA

<i>Parameter</i>	<i>Symbol</i>	<i>Value (at +25°C)</i>
Max. collector-emitter voltage	V_{CE}	4500V
Input supply voltage range	V_{DC}	+14 to +30V
Output voltage: ON/OFF voltage	V_{ON}/V_{OFF}	$\pm 15V$
Isolation testing voltage (V_{AC} RMS 50Hz / 1 min)	V_{ISOL}	10000V
Switching frequency (max.)	$f_{S \max}$	120kHz
Peak output current	I_G	$\pm 70A$
Peak output power	$P_{DC/DC}$	3W
Quiescent current typically	I_{DC}	0.25A (at 15V)
Max. input current at max. load	$I_{DC \max}$	0.50A (at 15V)
Coupling capacitance primary/secondary side (max.)	C_{io}	2pF
Switching frequency of isolated converter	$f_{SMPC \max}$	0.5MHz
Creepage distance		>30mm
Frequency of logic controller	f	20MHz
Operating temperature (measured on driver surface)	T_{OP}	-40 to +85°C
Storage temperature	T_{ST}	-40 to +85°C
Input driving and output error signal	optical	660nm
Turn-on delay time	t_{pdON}	400nsec
Turn-off delay time	t_{pdOFF}	400nsec
Typical time of soft shut down	t_{SSD}	1-2 μ sec
Max. system time between fault detection and error notification	t_{SYS}	100nsec
Time between detection of desaturation and gate voltage falling edge	t_{pDES}	300nsec

4. INTERFACES

<i>Interface</i>	<i>Part Type</i>	<i>Remarks</i>
Optical Receiver	HFBR-2531Z (Avago)	For suitable connectors see www.avagotech.com
Optical Transmitter	HFBR-1531Z (Avago)	
DC supply on PCB	FKC 2,5/2-STF-5,08 (Phoenix)	Connector: MSTBV 2,5/2-GF-5,08 (Phoenix)

5. CABLE LENGTH

For the connection between DC/DC converter and the driver board as well as for the power emitter connection we recommend normal cable as short as possible.